



DISTRIBUTION AND SHUT-OFF SYSTEM FOR DOMESTIC WATER SYSTEMS

K4 is a distribution and shut-off system from domestic water system that makes it possible to install devices in any environment without compromising its look. The distinctive design of the faceplates and their finish creates a pleasant effect when integrated with the environment.



MANY TECHNOLOGIES FOR A SINGLE SOLUTION

FAST AND SAFE TO INSTALL,
PRACTICAL TO USE



FASTEC



Connection system.
FASTEC®, fast, safe and compact.
The wide range of FASTEC® STORE fittings makes installation simple and flexible.
(see page 32)



DESIGN PLUS

Industrial design and innovative product awards at ISH 2015.



ACCESSIBILITY



INSIDE-OUTSIDE

Built to be installed inside and outside the building.

CERTIFIED

Installations for drinking water must be made to the highest standards to prevent trapping water, which could promote the development of microbe colonies (e.g. legionella). K4 valves were developed with build characteristics that prevent water from being trapped (DVGW W570).



CERTIFICATIONS AND TECHNICAL SPECIFICATIONS

Reference Standard for Metal Materials	DIN EN 13828 DVGW W570-1
Working pressure	PN10 (10 bar)
Temperature	0°C + 95 °C



SOFT TURN

Shut-off valve, 90° closure with anti-jamming engineered polymer ball.
(see page 37)



TOP-ENTRY

With the Top Entry system, the ball is fully removable and spare parts have been available for more than more than 30 years.
(see page 36)



LINK

Possibility of modular box coupling.
(see page 111)



SANDWICH BOX

Improves accessibility during installation.
(see page 112)

HIGH PERFORMANCE

The TECO solution with effective flow and installation in accordance with the EN 806-2 standard.
(see page 113)



COMPACT INSTALLATION

The smaller sizes are easier to integrate into the environment.





COMPACT
INSTALLATION



THE DESIGN FOR EVERY
LOOK

The innovative design of the K series faceplate integrates perfectly with any living environment.



D03 K4.3

WHITE



KPLD0301600

POLISHED CHROME

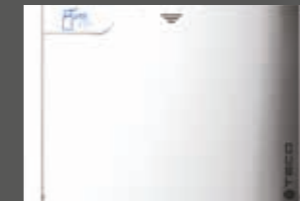

KPLD0301M00

SILVER

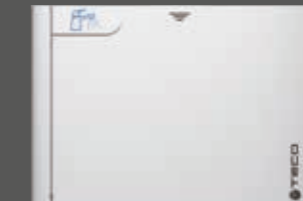

KPLD0301800

BLACK SOFT TOUCH

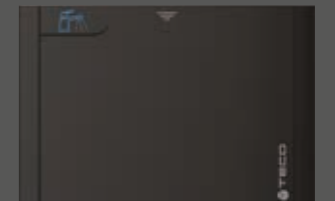

KPLD0301A00

B03 K4.0-K4.1-K4.2

WHITE

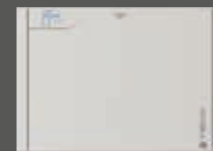

KPLB0301600

POLISHED CHROME

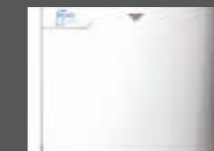

KPLB0301M00

SILVER



KPLB0301800

COPPER



KPLB0301700

BLACK SOFT TOUCH

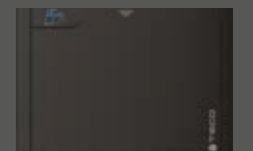

KPLB0301A00





ACCESSIBILITY

MAXIMUM CONTROL

The faceplate is available in various variants and finishes, allows access the operating controls and makes them easy to use.

The explanatory legend has been designed for the end user.

VALVE EXPLANATORY LEGEND

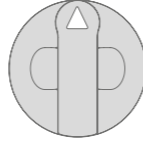
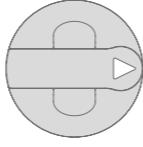
 CALDA HOT	 FREDDA COLD	APERTO OPEN	CHIUSO CLOSED
			
B03			

Clear instructions allow the end user to use it safely.

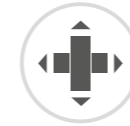

LINK

STRENGTH THROUGH UNITY

All valves in the K series for water systems (K4) and gas systems (K2) can be linked for secure and precise alignment.

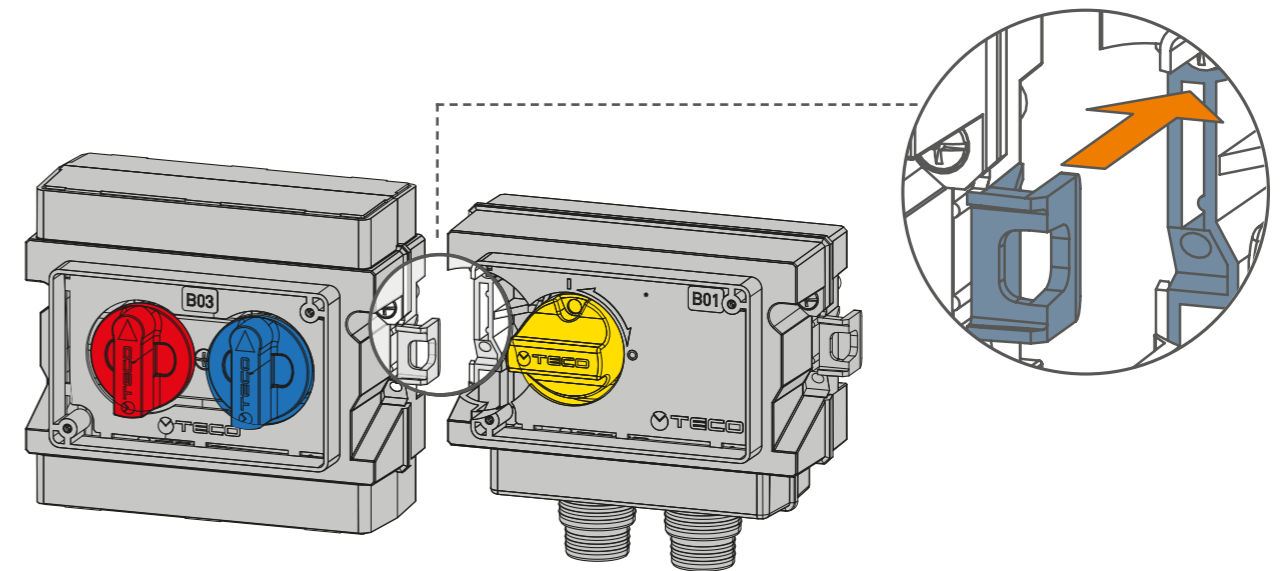
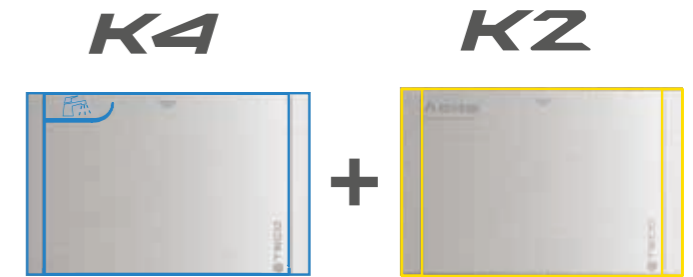

MODULAR EXTENSION KIT

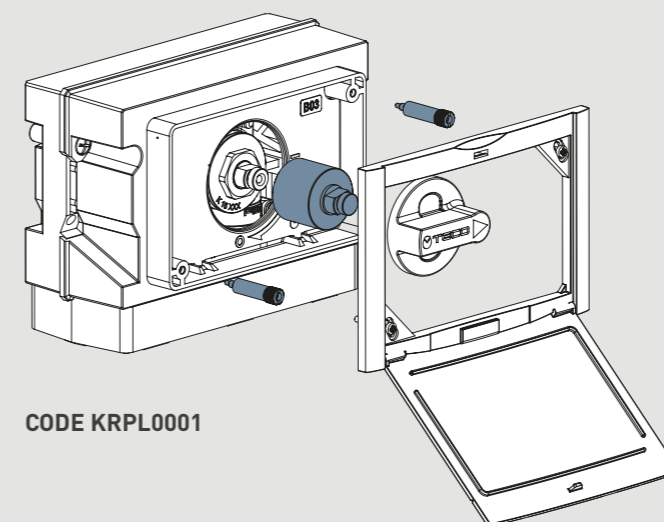

CODE KRPL001

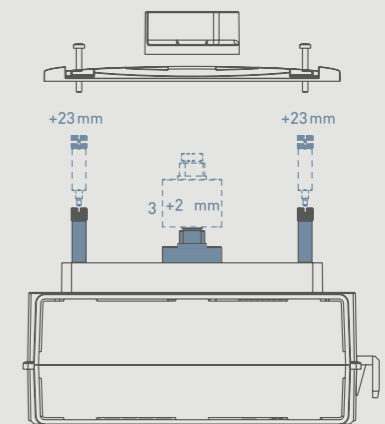

The extension kit is used whenever it is necessary to extend the operating control of the shut-off cock, so that the cock control can be in the optimal position.



SANDWICH BOX

PRACTICAL TO INSTALL

BENEFITS

- Less deep (can be installed in a 10 cm finished wall)
- Strong structure
- Special brackets can adjust the installation depth in the wall
- Easier access during installation

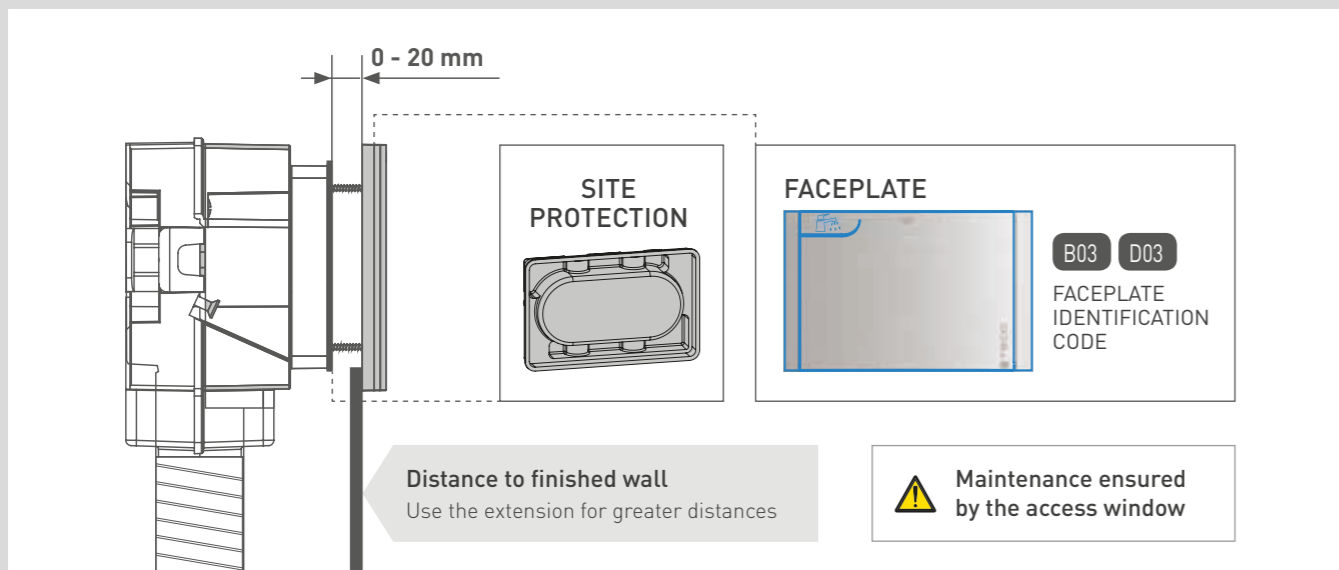

HIGH PERFORMANCE

TECO TOP ENTRY® ball valves have an effective flow that complies with EN 806-2 standard: Paragraph 6.1.

BENEFITS

- They have a low pressure drop
- They can replace screw valves, as recommended by EN 806-2

STANDARDS

The EN 806-2 standard: Paragraph 6.1: "Only install cut-off valves that do not excessively obstruct flow in the system (e.g. ball valves, gate valves)."

Solution TECO®
Installation to EN 806-2 standard

Common solution
with screw valve

TECO BALL VALVE

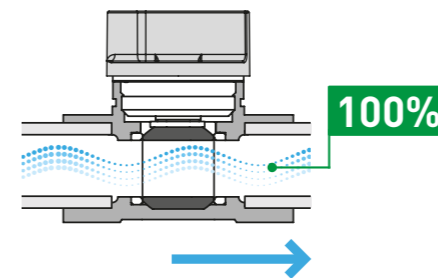

SCREW VALVE

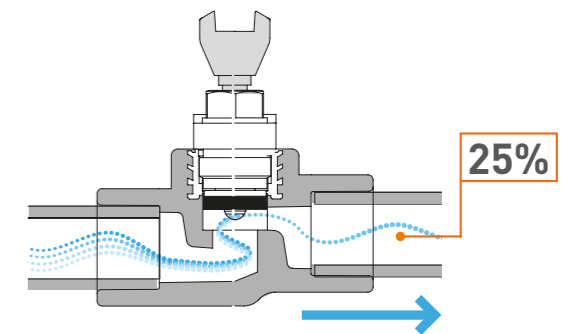

TECO MANIFOLD WITH OUTLET BALL VALVE

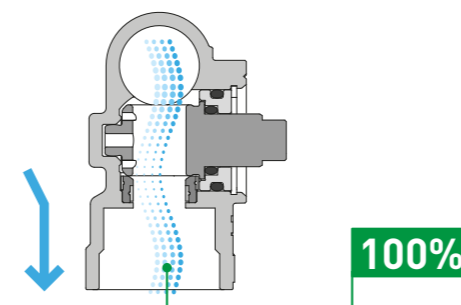

MANIFOLD WITH OUTLET SCREW VALVE

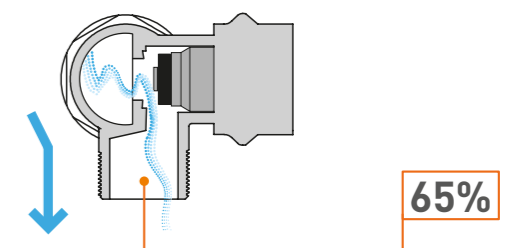

APPLICATIONS AND FUNCTIONS

K4.0

- MAIN SHUT-OFF (CENTRAL SYSTEM)
- BATHROOM SHUT-OFF ("T" SYSTEM)
- SHOWER SHUT-OFF
- KITCHEN SHUT-OFF
- MAIN BOILER SHUT-OFF



K4.1

- MAIN SHUT-OFF (AUTONOMOUS SYSTEM)
- WASHING MACHINE SHUT-OFF
- GARDEN / BALCONY SHUT-OFF



K4.2

- BATHROOM WATER DISTRIBUTION
- BATHROOM + KITCHEN WATER DISTRIBUTION
- SINGLE SHUT-OFF FOR HOT AND COLD WATER

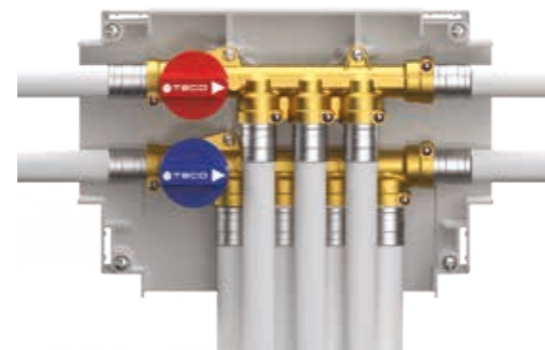

K4.3

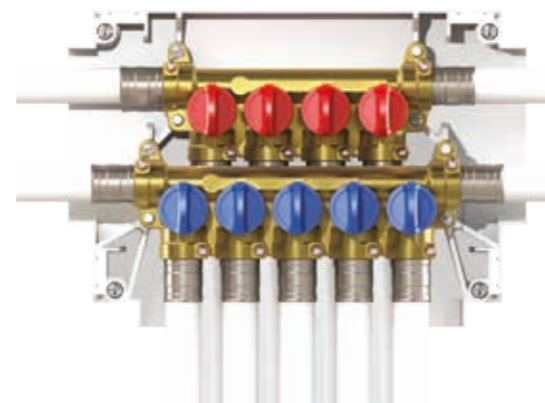

- BATHROOM WATER DISTRIBUTION WITH SINGLE SHUT-OFF
- BATHROOM + KITCHEN WATER DISTRIBUTION
- INDIVIDUAL SHUT-OFFS FOR HOT AND COLD WATER

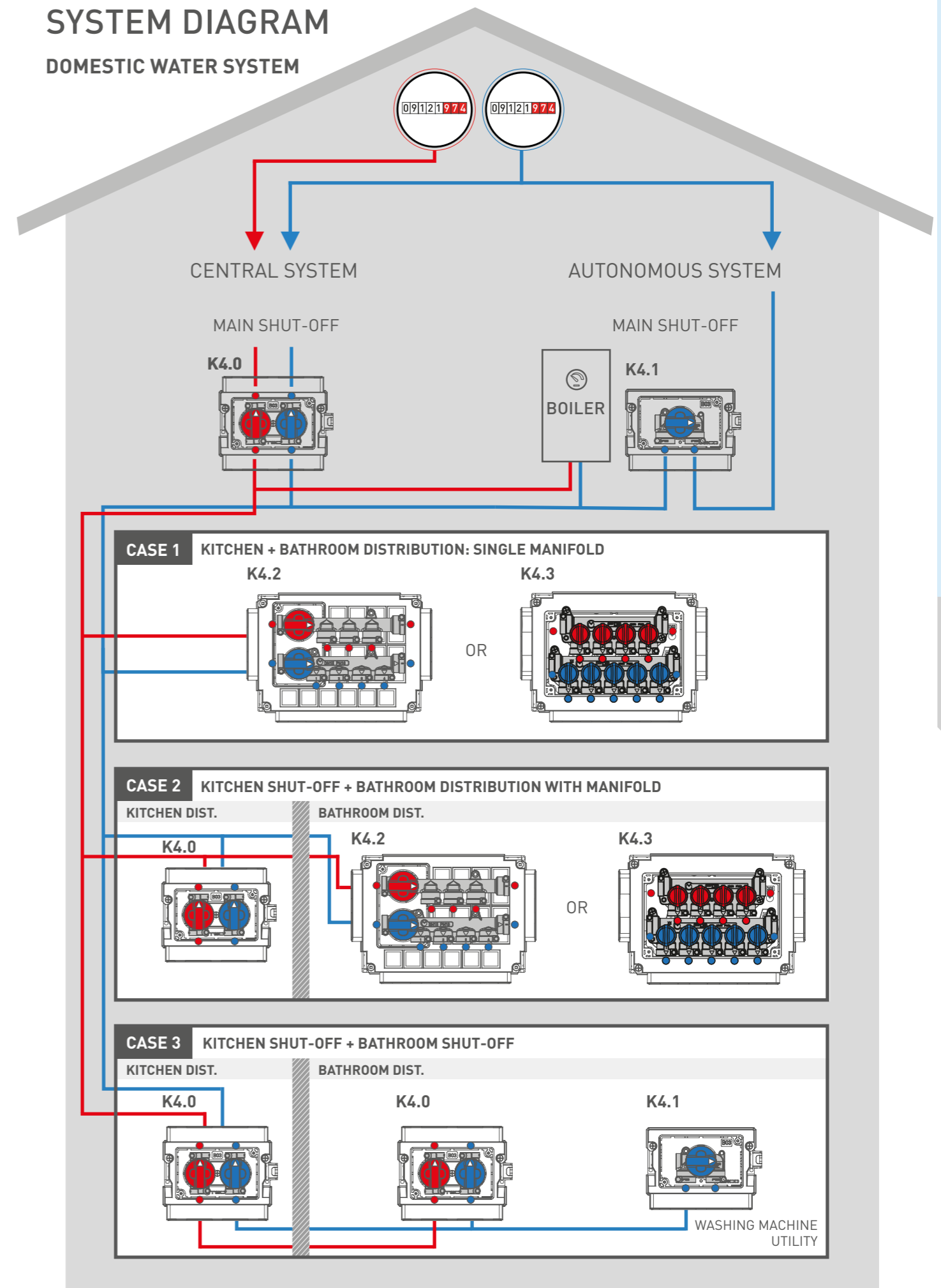

SYSTEM DIAGRAM

DOMESTIC WATER SYSTEM

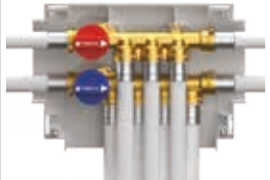
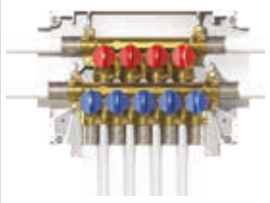
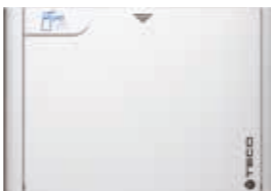

DEVICES		FACEPLATES						
K4.0	DN	CODE	CONNECTIONS					
			EK3/4" ISO 228-1	Rp1/2" EN 10226	Rp3/4" EN 10226	FASTEC		
						F13	F14	
	15	K400BE10100	•					
	15	K400B110100		•				
	20	K400B110200			•			
	15	F K400BF10100				•		
	20	F K400BF30100					•	
	15/20	F K400BF50100				•	•	
	15	K401BE10100	•					<ul style="list-style-type: none"> ○ WHITE KPLB0301600 ○ POLISHED CHROME KPLB0301M00 ○ SILVER KPLB0301800 ○ COPPER KPLB0301700 ○ BLACK SOFT TOUCH KPLB0301A00
	15	F K401BF10100				•		
	20	F K401BF30100					•	
	15	F K402BF10100 Outlets 5 + 4				•		
	15	F K403DF10100 Outlets 5 + 4				•		
	15	F K403DF10200 Outlets 4 + 3				•		



K4.3

MULTIPLE SHUT-OFF MANIFOLD

WINNER 2015
DESIGN PLUS

powered by: ISH

- K4.3 compact distribution manifold
- Shut-off valves on the individual outlets so there is no need for valves under the basin
- With flush-mounting, serviceable Sandwich box
- The FASTEC® connection is convenient and safe to work with, and does not require maintenance
- The faceplates allow full access to the manifold
- The faceplate Design and finishes are suitable for exposed installation
- TOP-ENTRY® removable shut-off valves with Soft Turn® full-flow anti-jamming balls



SPECIFICATIONS		TECHNOLOGIES		DESIGN FEATURES				
Material	Body	CW617 Brass		HIGH PERFORMANCE	SOFT TURN	CERTIFIED PRODUCT		
	Sandwich Box	PS					SANDWICH BOX	ACCESSIBILITY
	Balls	Engineered polymer						
Connections	FASTEC®		FASTEC®	TOP-ENTRY	COMPACT	DESIGN PLUS		
Working pressures	PN10 (EN13828)						SHUT-OFF BUILT INTO THE MANIFOLD	
Temperature	0-95 °C		DESIGN PLUS					
Standard and certification	DIN EN 13828 (KTW-W270) DVGW							

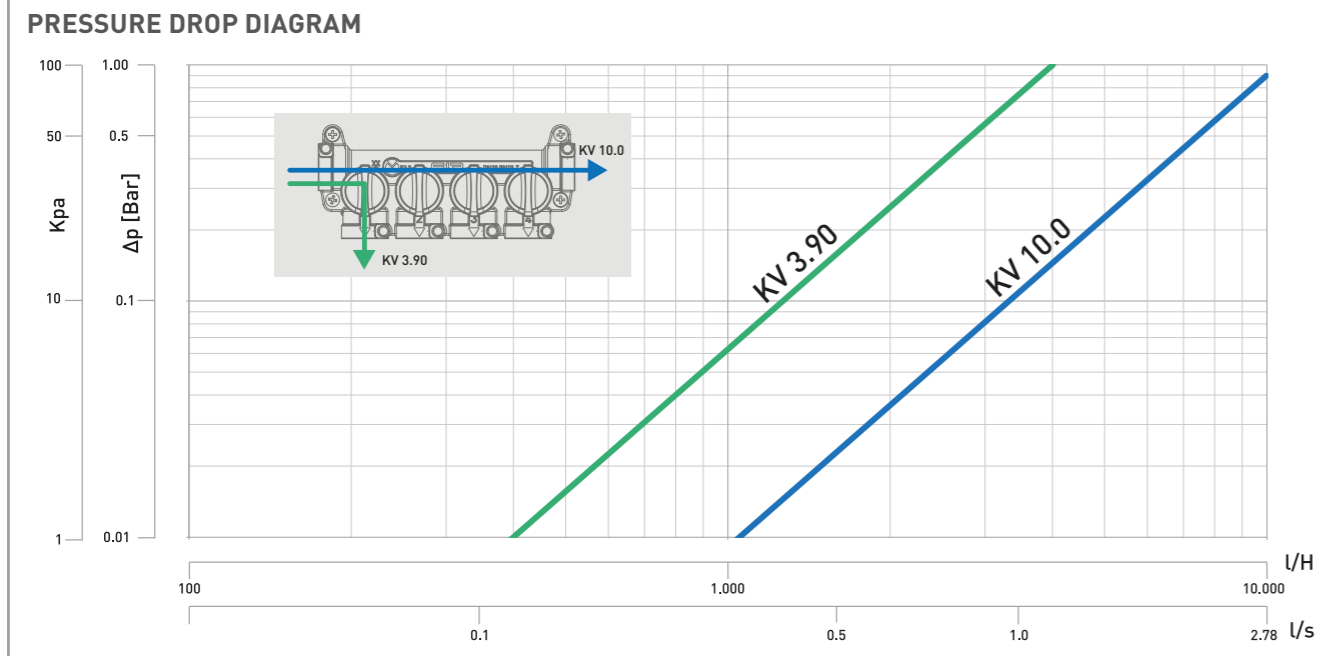

FASTEC®



CONNECTION KIT

The FASTEC® kit provides the plumbing connections for 2 manifolds, giving up to 10+8 outlets with individual shut-off valves.

The performance of the individual manifold outlets remain almost unaffected.

CODE KA00K00007

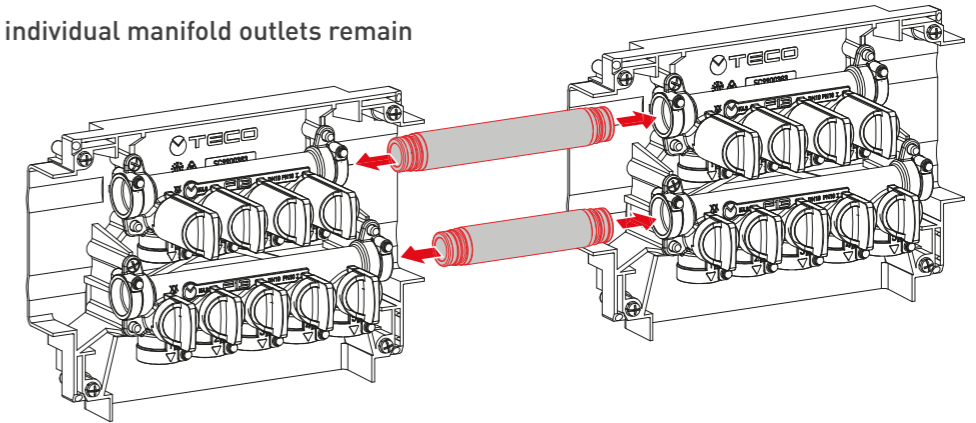

TWIN 1 FITTING

Fastec® Twin fittings make it possible to increase the number of connections. In this way you can simplify complex system solutions.

CODE KA00F10001

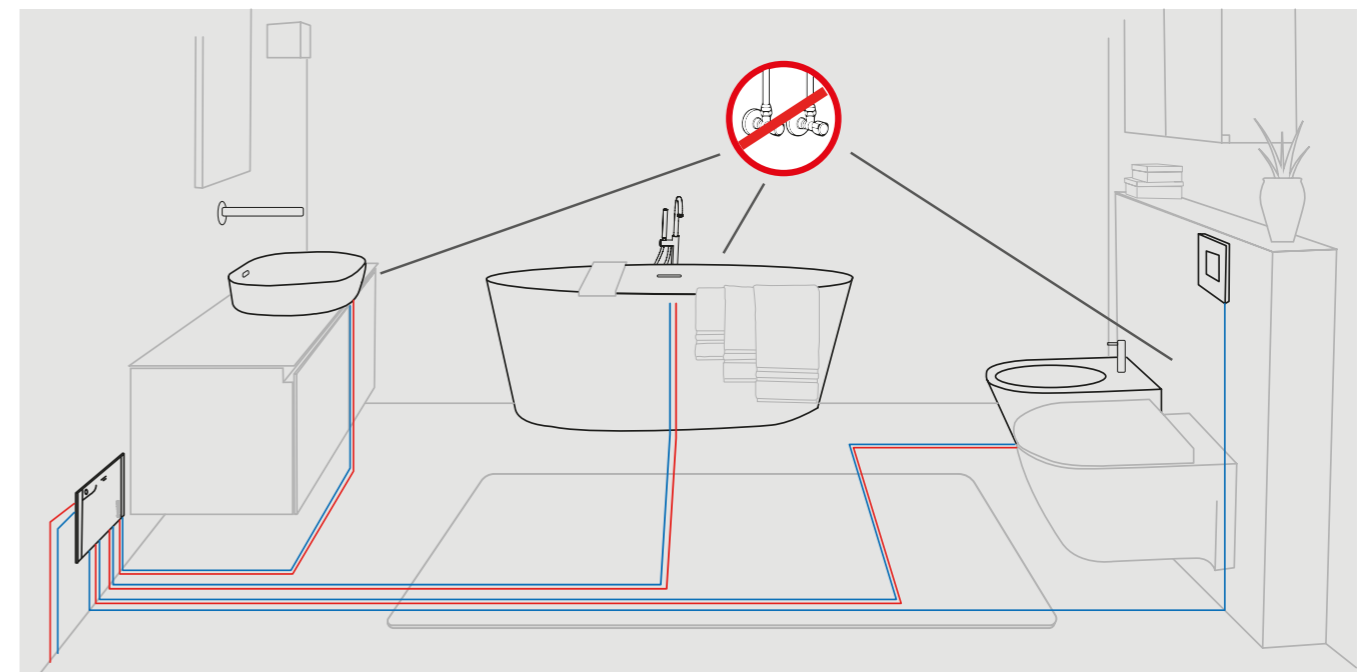
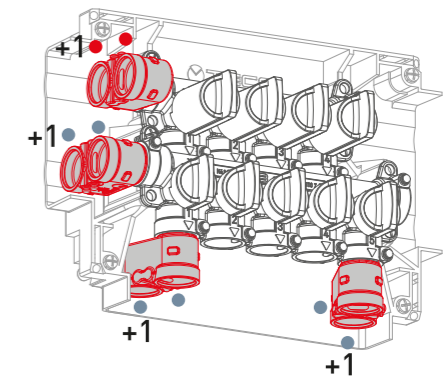

K4.3 MULTIPLE SHUT-OFF MANIFOLD FOR DOMESTIC WATER SYSTEMS

D03 COMPATIBLE FACEPLATE

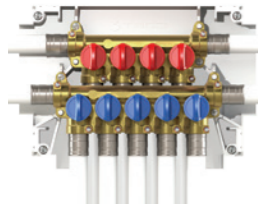

- PN10 (10 bar)
- 0 °C + 95 °C

INCLUDES: fixing bracket, site protection cover
DOES NOT INCLUDE: faceplate and fittings

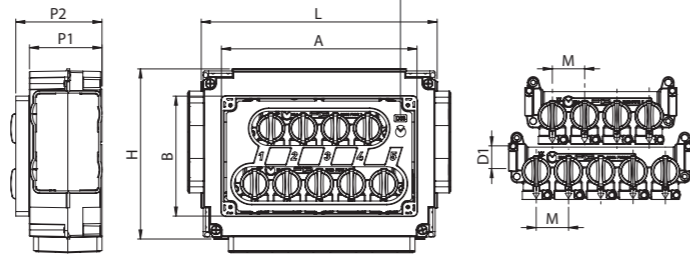

	Code	DN	Outlets	D1	M	L	H	P1	P2	A	B	Pack
F	K403DF10100	10	5 + 4	F13	32	234	170	72	85	194	119	5
F	K403DF10200	10	4 + 3	F13	32	234	170	72	85	194	119	5

FASTEC
STORE

THE K4.3 MANIFOLD USES
FASTEC® STORE FITTINGS ONLY

SEE PAGE 32

K4.3 Multiple shut-off manifold

A compact pre-assembled distribution manifold kit with 5+4 outlets, brass body with Top Entry® removable shut-off valves (5 or 4 cold + 4 or 3 hot) on each outlet in accordance with the **DIN EN 13828** standard, with "soft turn" seals and PPSU full-flow balls. Quick coupling fittings with FASTEC® technology and locking pin. Sandwich box housing made of impact-resistant PS, with plaster protection cover. Manually openable faceplate, available in four finishes.

Temperature: 0 °C + 95 °C.

Working pressure: 10 bar.

D03 FACEPLATES

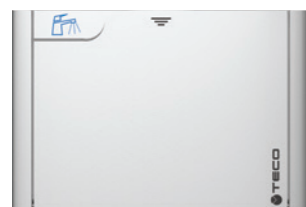

Faceplate 230x140mm.

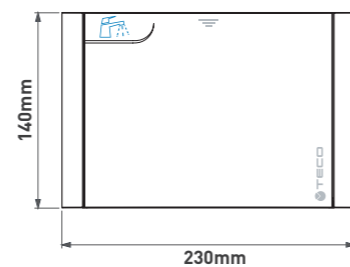

Code		Finish	Pack
KPLD0301600	○	White	5
KPLD0301M00	●	Polished chrome	1
KPLD0301800	●	Silver	1
KPLD0301A00	●	Black	1

K4.3 FASTEC® ACCESSORIES

FASTEC

TWIN 1 FITTING



Fastec TWIN
Fastec® connection

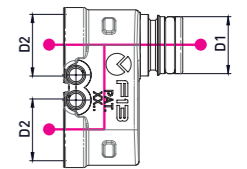

	Code	D1	D2	Pack
F	KA00F10001	F13M	2xF13F	10

CONNECTION KIT

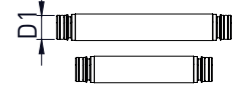
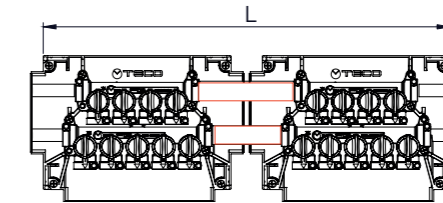
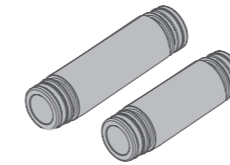

	Code	D1	Pack
F	KA00K00007	F13M	5

K4.3 ACCESSORIES

MAINTENANCE FRAME

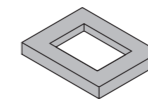

THE MAINTENANCE FRAME IS USED WHEN THE BOX IS INSTALLED INCORRECTLY AND PROTRUDES FROM THE WALL

	Code	DN	Pack
	KRPL0005	250x160x20 mm	1

K4.3 SPARE PARTS

TECO CONTROL KIT

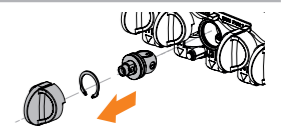
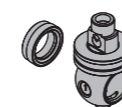

	Code	DN	Pack
	KR00K00002	10	1

HANDLE KIT

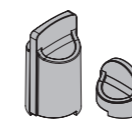

Control handle KIT (2)

	Code	Colour	Pack
	KA00K40004	BLUE / RED	1

K4.2

SINGLE SHUT-OFF MANIFOLD

- K4.2 compact distribution manifold
- Main shut-off
- With flush-mounting and serviceable Sandwich box
- The FASTEC® connection is convenient and safe to work with, and does not require maintenance
- The compact faceplates make it possible to access the shut-off valves
- The faceplate Design and finishes are suitable for exposed installation
- TOP-ENTRY® removable shut-off valves with Soft Turn® full-flow anti-jamming balls



SPECIFICATIONS		TECHNOLOGIES	DESIGN FEATURES								
Material	Body	CW617 Brass	HIGH PERFORMANCE	SOFT TURN	CERTIFIED PRODUCT	SANDWICH BOX	ACCESSIBILITY				
	Sandwich Box	PS									
	Balls	Engineered polymer									
Connections	FASTEC®	FASTEC®						TOP-ENTRY	COMPACT	DESIGN PLUS	DESIGN
Working pressures	PN10 (10 bar)										
Temperature	0°C + 95 °C										
Standard and certification	DIN EN 13828 (KTW-W270) DVGW										

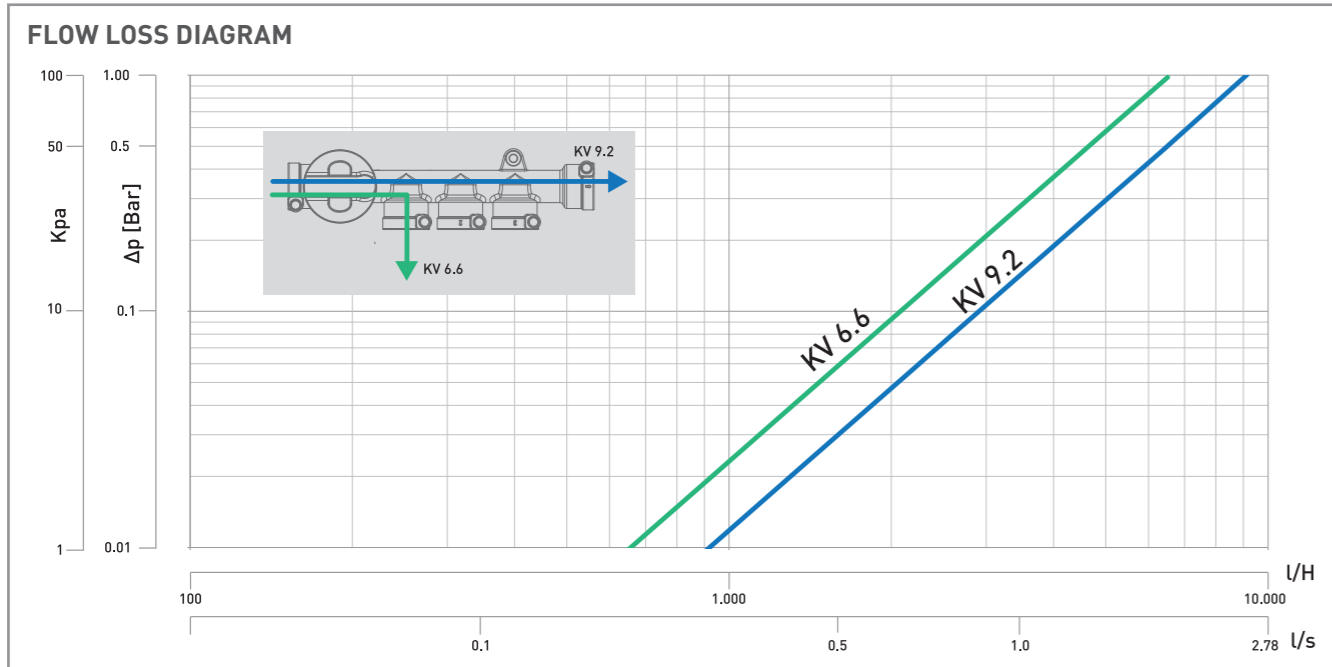

FASTEC®



TWIN 1 FITTING

Fastec® Twin fittings make it possible to increase the number of connections. In this way you can simplify complex system solutions.

CODE KA00F10001

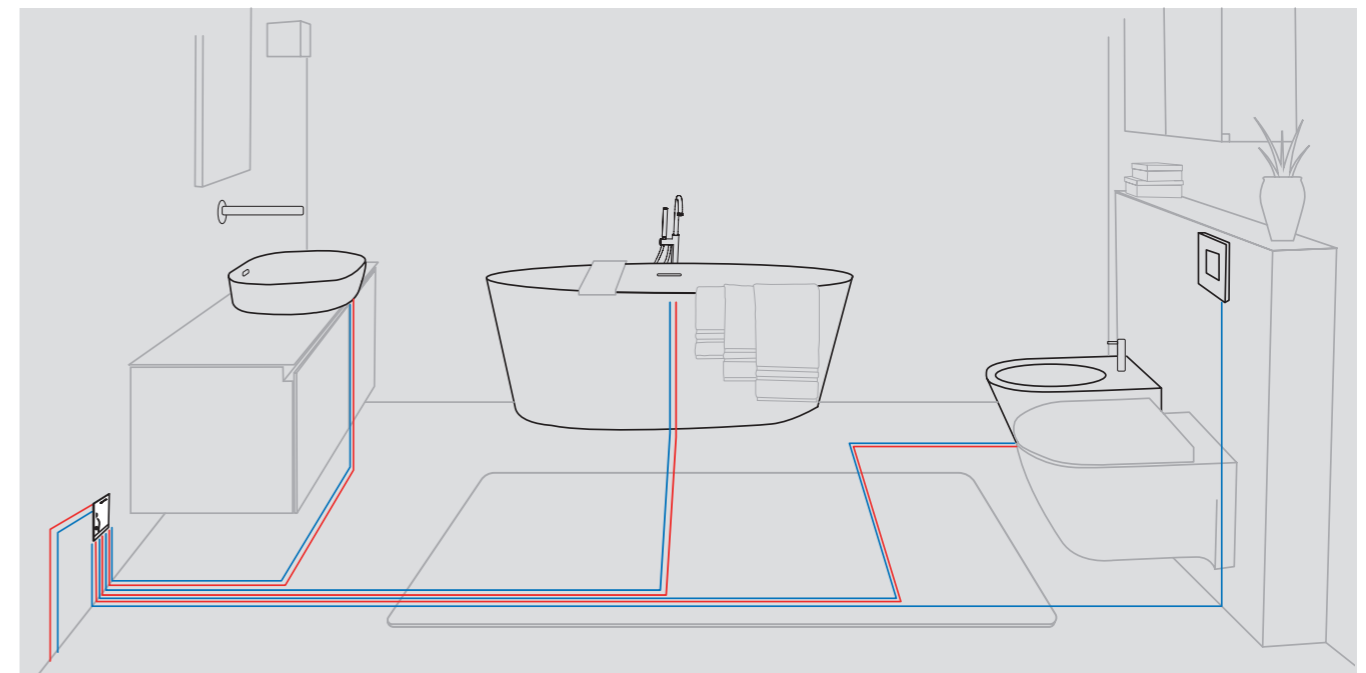
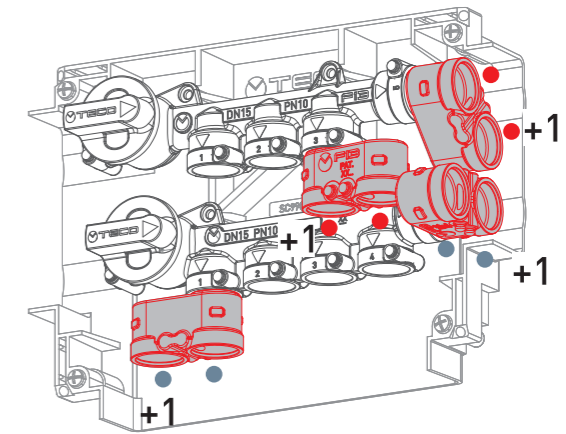

K4.2 SINGLE SHUT-OFF MANIFOLD FOR DOMESTIC WATER SYSTEMS

B03 COMPATIBLE FACEPLATE

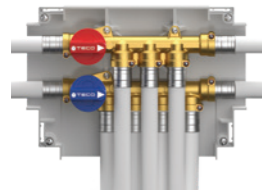

- PN10 (10 bar)
- 0 °C + 95 °C

INCLUDES: fixing bracket, site protection cover
DOES NOT INCLUDE: faceplate and fittings

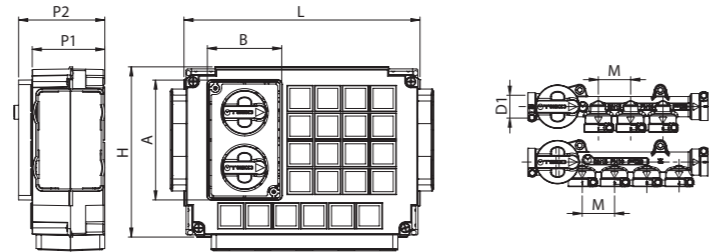

	Code	DN	D1	M	L	H	P1	P2	A	B	Faceplate	Pack
F	K402BF10100	10	F13	32	234	170	72	85	119	74	B03	5

FASTEC
STORE

THE K4.2 MANIFOLD USES
FASTEC® STORE FITTINGS ONLY

SEE PAGE 32

K4.2 Single Shut-off Manifold with 5+4 outlets

A compact pre-assembled distribution manifold kit with 5+4 outlets, brass body with Top Entry® removable hot/cold shut-off valves in accordance with the DIN EN 13828 standard, with "soft turn" seals and PPSU full-flow balls. Quick coupling fittings with FASTEC F13 technology and locking pin. Easily serviceable sandwich box made of impact-resistant PS, with depth adjustment brackets and plaster protection cover.

Opens and closes by turning the handles by 90°, manually openable faceplate available in five finishes.

Temperature: 0 °C + 95 °C.

Working pressure: 10 bar.

B03 FACEPLATES

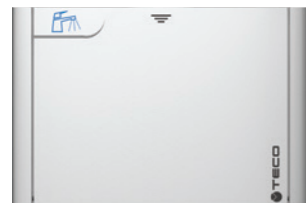

Faceplate 135x90mm.

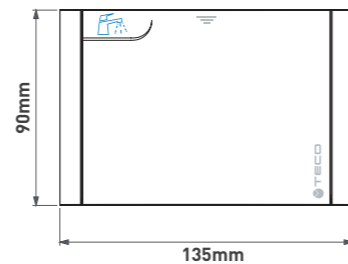

Code		Finish	Pack
KPLB0301600	○	White	10
KPLB0301M00	●	Polished chrome	5
KPLB0301800	●	Silver	5
KPLB0301A00	●	Black	5
KPLB0301700	●	Copper	5

K4.2 FASTEC® ACCESSORIES

FASTEC

TWIN 1 FITTING



TWIN fitting
Fastec® connection

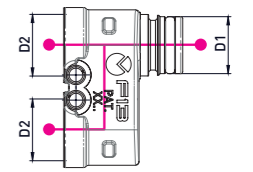

	Code	D1	D2	Pack
F	KA00F10001	F13M	2xF13F	10

K4.2 ACCESSORIES

MODULAR EXTENSION KIT

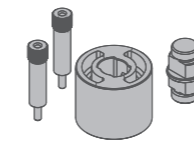

Extension 23mm modular + screws + faceplate extensions

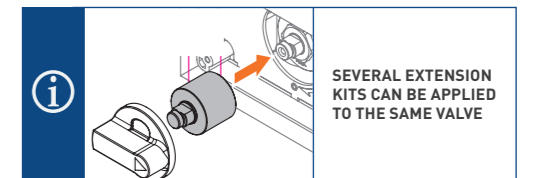

SEVERAL EXTENSION KITS CAN BE APPLIED TO THE SAME VALVE

	Code	Pack
	KPR0001	1

B03 MAINTENANCE FRAME

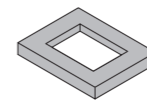

THE MAINTENANCE FRAME IS USED WHEN THE BOX IS INSTALLED INCORRECTLY AND PROTRUDES FROM THE WALL

	Code	DN	Pack
	KRPL0004	150x105x15 mm	1

K4.2 SPARE PARTS

TECO CONTROL KIT

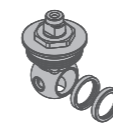

TECO-CONTROL spare parts kit

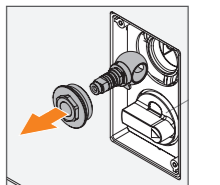

	Code	DN	Pack
	KR00K00001	15	1

HANDLE KIT

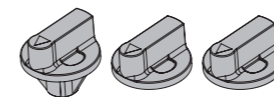

2 BLUE (TOP + BOTTOM) 1 RED

	Code	Colour	Pack
	KA00K40001	BLUE / RED	1

K4.1

SINGLE SHUT-OFF

- K4.1 compact shut-off cock
- Main shut-off
- With flush-mounting, serviceable Sandwich box
- The FASTEC® connection is convenient and safe to work with
- The faceplates make it possible to access the shut-off valves
- The faceplate Design and finishes are suitable for exposed installation
- TOP-ENTRY® removable shut-off valves with Soft Turn® anti-jamming ball



SPECIFICATIONS		TECHNOLOGIES		DESIGN FEATURES			
Material	Body	CW617 Brass		HIGH PERFORMANCE	SOFT TURN	CERTIFIED PRODUCT	
	Sandwich Box	PS					SANDWICH BOX
	Balls	Engineered polymer					
Connections	FASTEC® Eurocono (ISO 228-1)		FASTEC®	TOP-ENTRY	COMPACT		
Working pressures	PN10 (10 bar)					DESIGN PLUS	
Temperature	0 °C + 95 °C						DESIGN
Standard and certification	DIN EN 13828 (KTW-W270) DVGW		LINK				

FLOW LOSS DIAGRAM

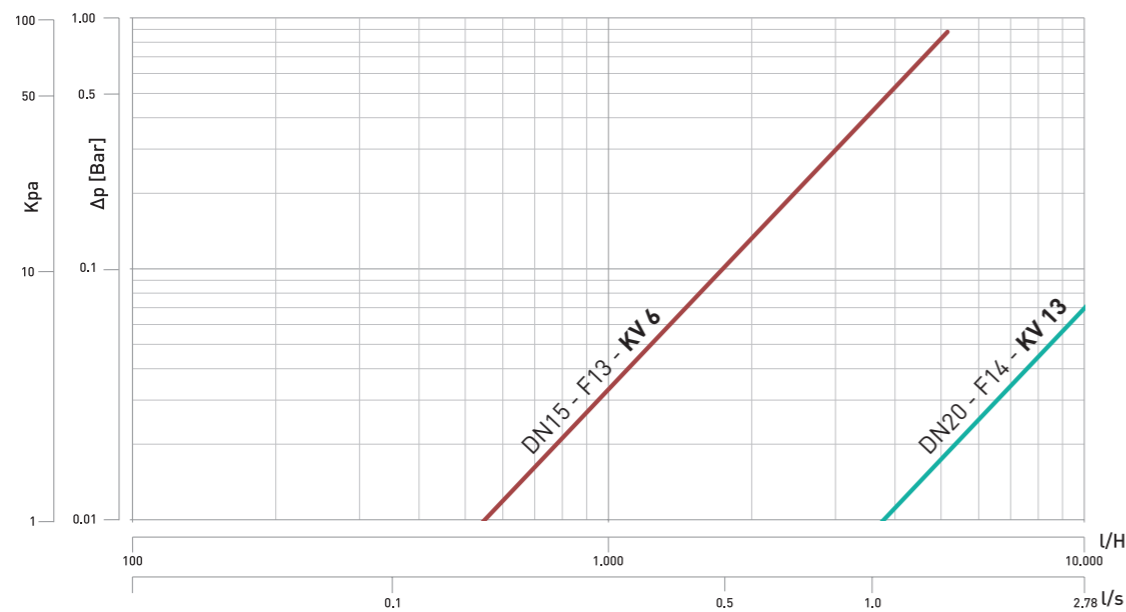

FASTEC®



TWIN 1 FITTING

Fastec® Twin fittings make it possible to increase the number of connections. In this way you can simplify complex system solutions.

The FASTEC® TWIN Fitting can be used either upstream or downstream from the device.

CODE KA00F10001

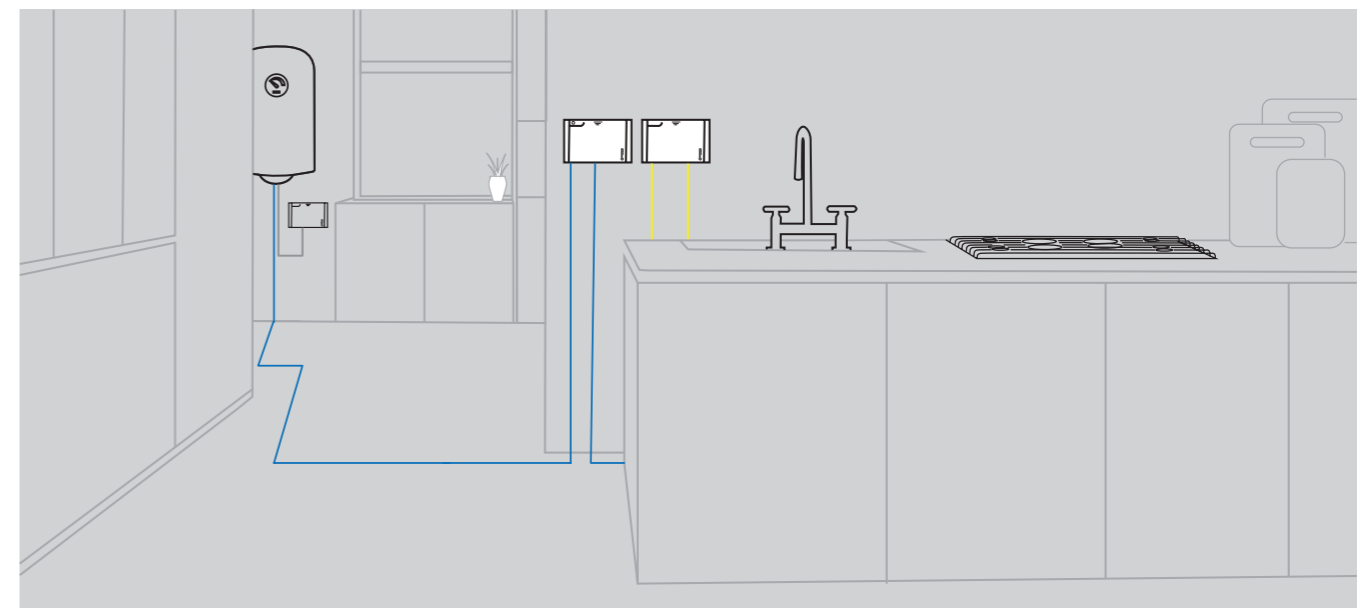
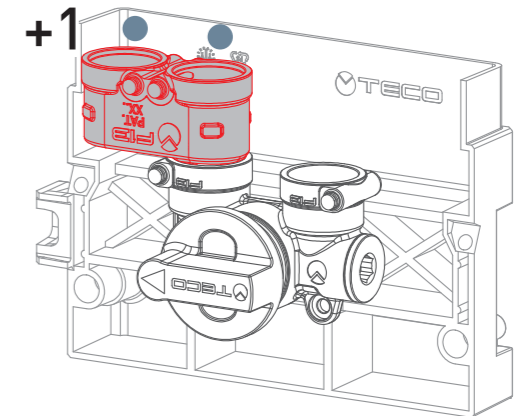

K4.1 SHUT-OFF VALVES FOR DOMESTIC WATER SYSTEMS



- PN10 (10 bar)
- 0 °C + 95 °C

INCLUDES: fixing bracket, site protection cover
DOES NOT INCLUDE: faceplate and fittings

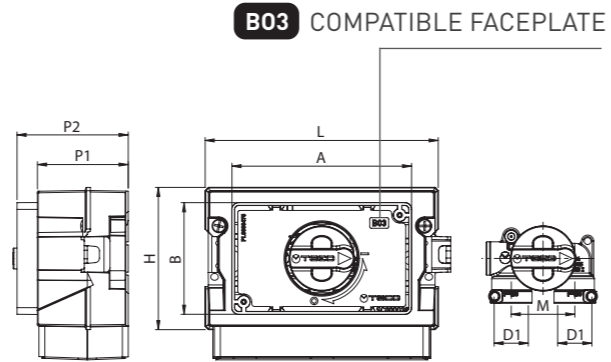

Code	DN	D1	M	L	H	P1	P2	A	B	Faceplate	Pack
K401BE10100	15	EK3/4"	42	154	94	60	73	119	74	B03	10
F K401BF10100	15	F13	42	154	94	60	73	119	74	B03	10
F K401BF30100	20	F14	52.5	194	94	60	73	119	74	B03	5

FASTEC
STORE

THE WHOLE RANGE OF FASTEC® FITTINGS IS DESCRIBED ON PAGE 32

K4.1 Single shut-off valve

Removable ball valve with brass body and Top Entry® system, conforms to the DIN EN 13828 standard, with light "Soft turn" control, complete with easily serviceable sandwich box. Brackets and protection covers included. Opens and closes by operating the handle, manually openable faceplate available in five finishes.

Temperature: 0 °C + 95 °C.

Working pressure: 10 bar.

B03 FACEPLATES

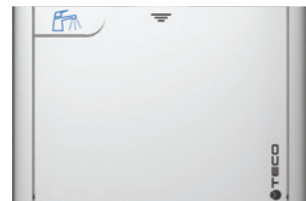

Faceplate 135x90mm.

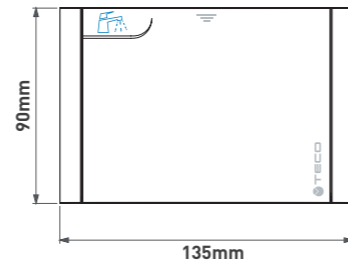

Code	Finish	Pack
KPLB0301600	White	10
KPLB0301M00	Polished chrome	5
KPLB0301800	Silver	5
KPLB0301A00	Black	5
KPLB0301700	Copper	5

K4.1 FASTEC® ACCESSORIES

FASTEC

TWIN 1 FITTING



TWIN fitting
Fastec® connection

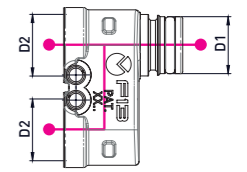

Code	D1	D2	Pack
F KA00F10001	F13M	2xF13F	10

K4.1 ACCESSORIES

ADAPTER TO CONVERT A EUROCONO SEAL TO A FLAT SEAL



Compatible with all fittings
with an ISO228 swivel nut

Code	D1 ISO 228-1	Pack
AP004003	3/4"-EK	10

EUROCONO COMPRESSION FITTING FOR MULTI-LAYER COMPOSITE PIPES

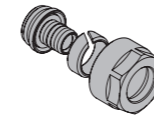

Code	D1 ISO 228-1	D2 PIPE	Pack
KA00K00005	3/4"-EK	16x2	10
KA00K00006	3/4"-EK	20x2	10

K4.1 ACCESSORIES

MODULAR EXTENSION KIT

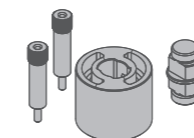

Extension -23mm- modular +
screws + faceplate extensions

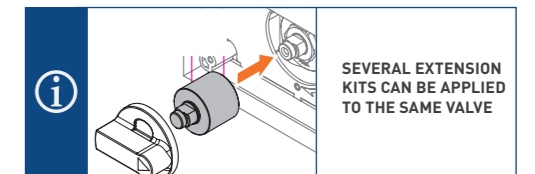

SEVERAL EXTENSION
KITS CAN BE APPLIED
TO THE SAME VALVE

Code	Pack
KPR0001	1

B03 MAINTENANCE FRAME

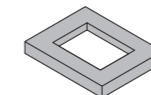

THE MAINTENANCE FRAME IS USED
WHEN THE BOX IS INSTALLED INCORRECTLY AND
PROTRUDES FROM THE WALL

Code	DN	Pack
KRPL0004	150x105x15 mm	1

K4.1 SPARE PARTS

TECO CONTROL KIT

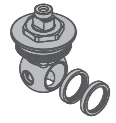

TECO-CONTROL spare parts kit

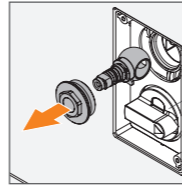

Code	DN	Pack
KR00K00001	15	1

HANDLE KIT

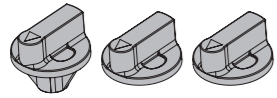

2 BLUE (TOP + BOTTOM) 1 RED

Code	Colour	Pack
KA00K40001	BLUE / RED	1



K4.0

DUAL SHUT-OFF

- K4.0 is a compact shut-off kit
- Main shut-off
- With flush-mounting, serviceable Sandwich box
- The FASTEC® connection is convenient and safe to work with
- The compact faceplates make it possible to access the shut-off valves
- The faceplate Design is suitable for exposed installation
- TOP-ENTRY® removable shut-off valves with Soft Turn® full-flow anti-jamming balls

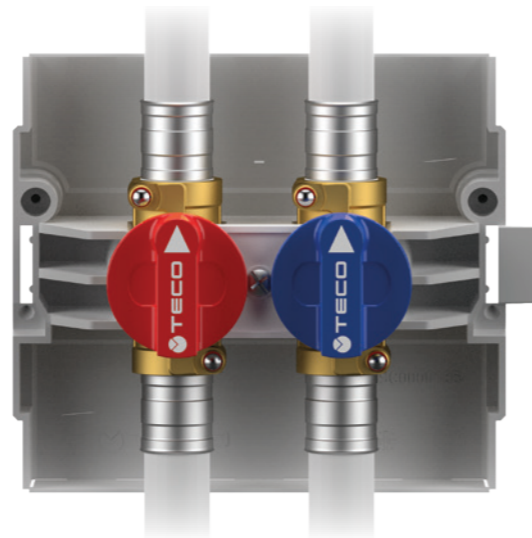

SPECIFICATIONS		TECHNOLOGIES		DESIGN FEATURES		
Material	Body	CW617 Brass		HIGH PERFORMANCE SOFT TURN CERTIFIED PRODUCT SANDWICH BOX ACCESSIBILITY		
	Sandwich Box	PS				
	Balls	Engineered polymer				
Connections	FASTEC® Eurocono (ISO 228-1) F threaded (EN10226)		FASTEC® TOP-ENTRY COMPACT DESIGN PLUS			
Working pressures	PN10 (10 bar)					
Temperature	0 °C + 95 °C					
Standard and certification	DIN EN 13828 (KTW-W270) DVGW					

FLOW LOSS DIAGRAM

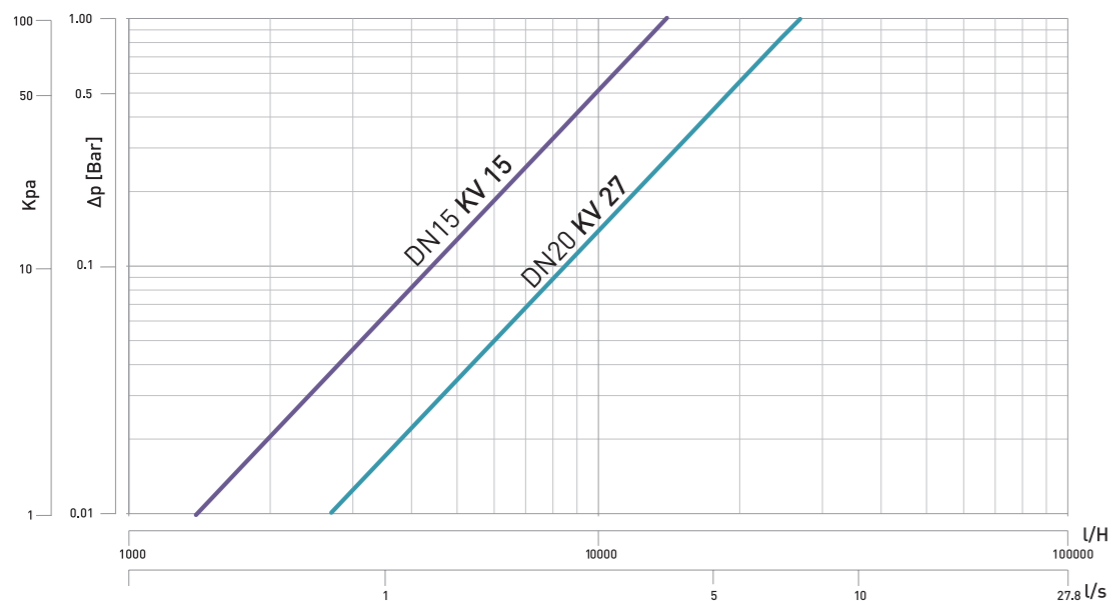

FASTEC®



TWIN 2 FITTING

CODE KA00F10002

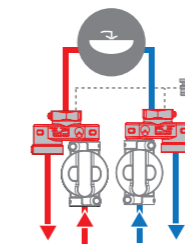
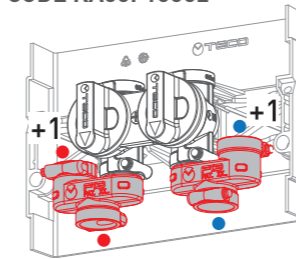

FASTEC® plug
CODE KA00K0002

TWIN 1 FITTING

CODE KA00F10001

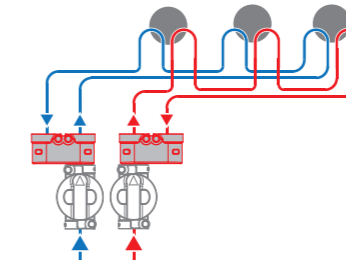
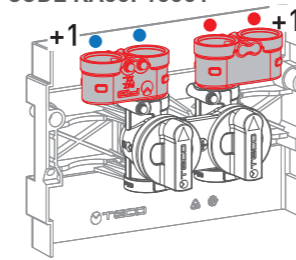

TWIN 1 FITTING

CODE KA00F10001

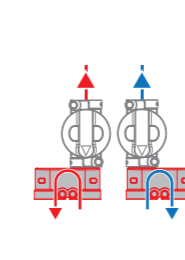
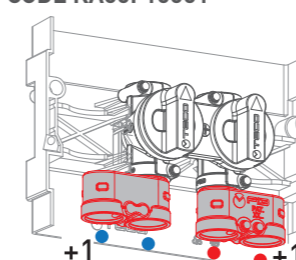

Fastec® Twin fittings make it possible to increase the number of connections. In this way you can simplify complex system solutions.

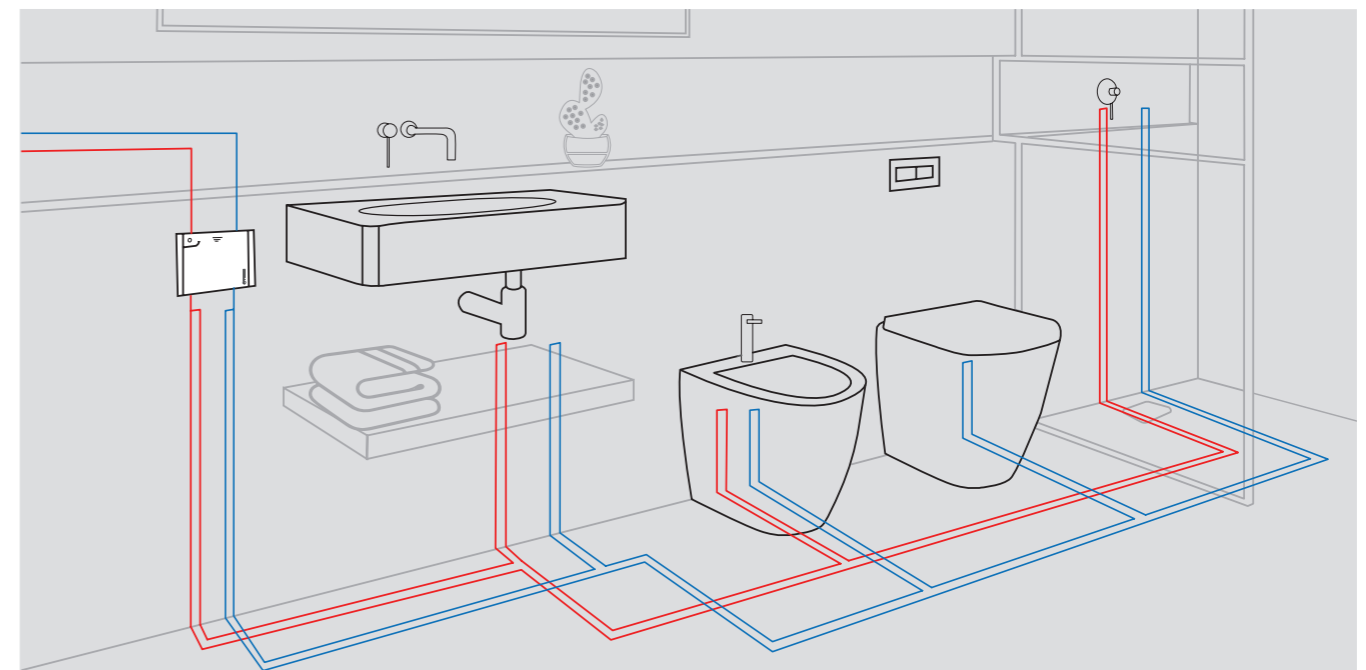

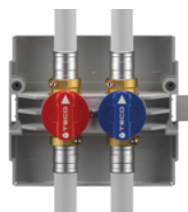

- PN10 (10 bar)
- 0 °C + 95 °C

INCLUDES: fixing bracket, site protection cover
 DOES NOT INCLUDE: faceplate and fittings

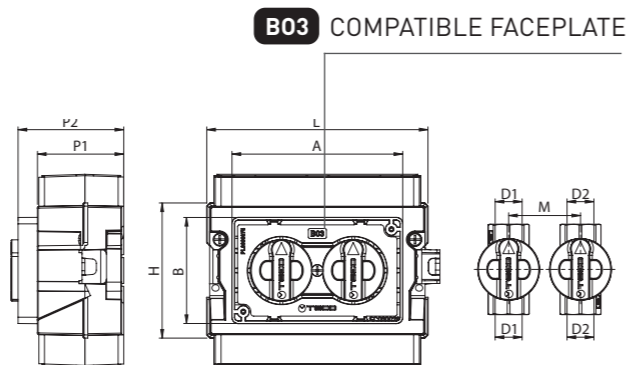

B03 COMPATIBLE FACEPLATE

	Code	DN	D1	D2	M	L	H	P1	P2	A	B	Pack
	K400BE10100	15	EK3/4"	EK3/4"	50	154	115	60	73	119	74	10
F	K400BF10100	15	F13	F13	50	194	115	60	73	119	74	10
	K400B110100	15	Rp1/2"	Rp1/2"	50	154	115	60	73	119	74	10
F	K400BF30100	20	F14	F14	50	194	154	60	73	119	74	5
	K400B110200	20	Rp3/4"	Rp3/4"	50	194	154	60	73	119	74	5
F	K400BF50100	15/20	F13	F14	50	194	154	60	73	119	74	5



THE WHOLE RANGE OF FASTEC® FITTINGS IS DESCRIBED ON PAGE 32

K4.0 "DUPLEX" dual shut-off valve

Kit with dual hot and cold valve with removable ball, conforms to the **DIN EN 13828** standard, with light "soft turn" control, complete with easily serviceable sandwich box. Brass body with Top Entry system. Brackets and protection covers included. Opens and closes by operating the handles, manually openable faceplate available in five finishes. Temperature: 0 °C + 95 °C. Working pressure: 10 bar.

B03 FACEPLATES

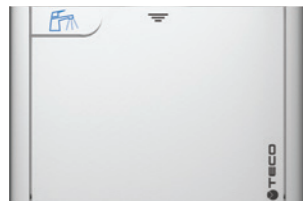

Faceplate 135x90mm.

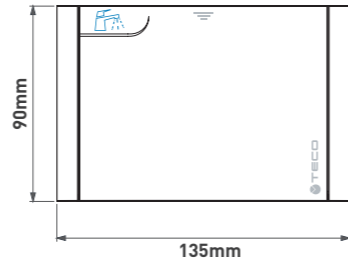

Code		Finish	Pack
KPLB0301600	○	White	10
KPLB0301M00	●	Polished chrome	5
KPLB0301800	●	Silver	5
KPLB0301A00	●	Black	5
KPLB0301700	●	Copper	5

TWIN 1 FITTING



TWIN fitting
Fastec® connection

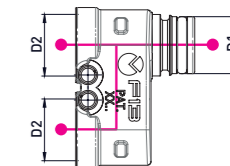

	Code	D1	D2	Pack
F	KA00F10001	F13M	2xF13F	10

TWIN 2 FITTING

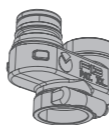

TWIN T fitting
FASTEC® connection

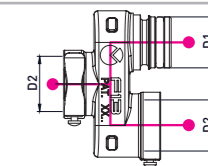

	Code	D1	D2	Pack
F	KA00F10002	F13M	2xF13F	10

K4.0 FITTINGS

EUROCONO ADAPTER - FLAT SEAL



EUROCONO adapter - Flat Seal

	Code	D1 ISO 228-1	Pack
	AP004003	3/4"-EK	10

EUROCONO COMPRESSION FITTING FOR MULTI-LAYER COMPOSITE PIPES

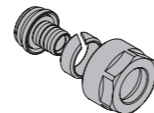

EUROCONO compression fitting for connecting multi-layer composite pipes

	Code	D1 ISO 228-1	D2 PIPE	Pack
	KA00K00005	3/4"-EK	16x2	10
	KA00K00006	3/4"-EK	20x2	10

K4.0 ACCESSORIES

MODULAR EXTENSION KIT

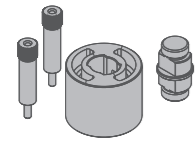

Extension -23mm- modular + screws + faceplate extensions

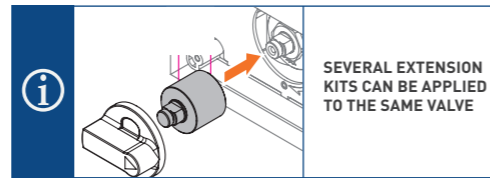

SEVERAL EXTENSION KITS CAN BE APPLIED TO THE SAME VALVE

Code	Pack
KPR0001	1

B03 MAINTENANCE FRAME

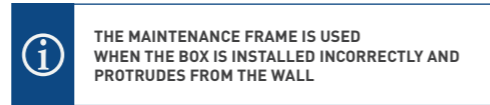
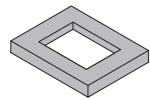

THE MAINTENANCE FRAME IS USED WHEN THE BOX IS INSTALLED INCORRECTLY AND PROTRUDES FROM THE WALL

Code	DN	Pack
KRPL0004	150x105x15 mm	1

K4.0 SPARE PARTS

TECO CONTROL KIT



TECO-CONTROL spare parts kit

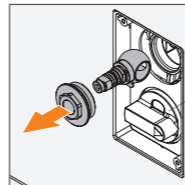

Code	DN	Pack
KR00K00001	15	1

HANDLE KIT

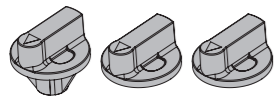

2 BLUE (TOP + BOTTOM) 1 RED

Code	Colour	Pack
KA00K40001	BLUE / RED	1

